

SMART WATER SOLUTIONS

Opportunities and challenges for the water sector

Presentation of lessons learned from water and wastewater utilities in Denmark, Finland, Norway and Sweden



Table of Contents

- 3 Nordic Smart Water Solutions - Preface
- 4 Our Associations
- 4 Nordic Innovation
- 5 Making digital solutions smart for the water sector
- 7 Our selection of Smart water solutions in the Nordics
- 8 BlueBox – Safer Water Distribution in Halden, Norway
- 10 Smart urban water systems using real-time management in Tampere, Finland
- 12 An efficient water utility using digital wastewater developed in Provas Network, Haderslev, Denmark
- 14 Lungegaarden Data Lake in Bergen, Norway
- 16 Smart Cities - Greenergy in Fredrikstad, Norway
- 18 Stationary Overflow Monitoring System (SOMS) saves operation and ensures the water environment in Skanderborg, Denmark
- 20 Use of X-band weather radar data against urban flooding in Southern Sweden
- 22 Future City Flow (FCF), Sweden
- 24 For more information – Contacts at the Nordic associations





Nordic Smart Water Solutions - Preface

Is smart water the answer to our water and climate challenges? Will digitalization improve our services towards customers and the way we protect water and environment?

As we are looking into a future with increased uncertainties, also in our Nordic welfare states, the questions above inspired us to produce this booklet. It represents our ambition of sharing experiences from smart water solutions in the Nordic region worldwide in order to enable us to overcome challenges such as:

- Climate change, with more extreme events, more intense rain and stormwater and increased risk of flooding and freshwater pollution.
- The burden of industrialized farming and the use of pesticides that has put water resources under stress today and for future generations.
- Increased urbanization is a global trend, but also in the Nordic countries more and more people are moving towards cities.

Water utilities of today need to increase investments and reinvestments in their infrastructure, in order to cope with the increased amounts

of rainfall, manage combined sewer overflows and floods, while ensuring a cost-effective and secure supply.

These challenges will define the water sector of the future. If we in the water sector combine our efforts and learn from each other in our region and at European and global level, we can help each other overcome the challenges.

For this reason, four Nordic water and wastewater associations: DANVA, FIWA, Norsk Vann and Svenskt Vatten decided to explore how development of smart and digital solutions can optimize the water sector and improve our solutions. By developing this booklet, we hope to give inspiration from Nordic experiences to a global audience.

We present cases selected by our organisations, amongst our members. The objective has been to give a broad picture of existing smart water solutions from Nordic water utilities. A common feature of the solutions is that they have emerged through close cooperation between utilities, municipalities and their partners.

When looking at the cases, we as water associations feel convinced that the strategic investments in digital solutions of the water sector would help to create the best solutions for our customers and the environment, but it is also important to focus our investments with a view to deliver on our core tasks as water and wastewater utilities.

As organisations, this is our responsibility, not only for our members, but also at an international level where smarter water solutions may guide us towards implementing the UN Sustainable Development Goals (SDG's). We hope that these examples will inspire you to engage further into the field of smart and digital water solutions.

Thomas Breen
CEO, Norsk Vann

Pär Dalhielm
CEO, Svenskt Vatten

Osmo Seppälä
CEO, FIWA

Carl-Emil Larsen
CEO, DANVA

Our Associations

The four Nordic Water and Wastewater Associations: DANVA - Danish Water and Wastewater Association, FIWA - Finnish Water Utilities Association, Norsk Vann - Norwegian Water and Svenskt Vatten – Swedish Water and Wastewater Association are national associations representing the four countries' water and wastewater utilities. We act on behalf of our members, which are mainly municipal water and wastewater utilities and water utilities in public ownership.

Our members supply drinking water, manage and treat wastewater and discharge this into recipients and are responsible for stormwater manage-

The Four Water Associations represent more than 11,1 million households and more than 1,9 billion m³ sold water

ment and climate change adaptation in cooperation with other actors in the water sector. Some are multi-utilities, who are also responsible for solid waste, district heating and cooling or other supply related tasks.

We are members of EurEau, the European Federation of national associations of water services representing 29 countries. Through EurEau, we reach out to the European water sector and share experiences amongst European water and wastewater utilities.

Nordic Innovation

This Project, the booklet and the international presentation of our findings, has been supported by #Nordic Innovation, a Nordic organisation working to promote cross-border trade and innovation.

Nordic innovation is funded by the Nordic Council, which is the official inter-governmental body for cooperation in the Nordic Region. The Nordic coop-

eration consists of Sweden, Denmark, Norway, Finland and Iceland, in addition to the self-governing areas of Aaland Islands, Greenland and the Faroe Islands. With its 26 million inhabitants, the Nordic cooperation is one of the most comprehensive regional partnerships in the world.

See more at www.nordicinnovation.org



Making digital solutions smart for the water sector

Digital technologies are already playing a central role in the water sector, but with future demands, the digital technologies will have an increasingly central role to play in ensuring innovation and progress in the water sector.

In the future, water companies need to focus more on development and innovation based on digital solutions.

For the utilities, it is important to discuss a definition of smart water that includes and takes the core task

of utilities as its starting point. We will need an understanding of the concept, where focus is on not only Information and Communications technology (ICT) and technologies, but also on how tools, models and technologies can improve plan-

ning and management and linking water related elements in the cities, between city and utility and across sectors. To be truly water smart and have water smart cities we need solutions based on smart governance and management systems that cre- ▶



Carl-Emil Larsen,
DANVA

"In Denmark, we are working towards a climate neutral water sector. Linking energy and water efficient solutions, getting more information about where and how we use energy, and can save energy, is an important step in that direction. A smarter water sector will guide our work towards climate neutrality."



Pär Dalhielm,
Svenskt Vatten

"In the water sector, we are facing recruitment challenges as in many other sectors. Smarter technologies and more data-based solutions will increase efficiency and improve customer satisfaction. And, if we are working smarter, it will help us attract young engineers to the sector and use their talents in better ways."

- ▶ create an enabling environment for better services and more liveable cities.

Based on the core tasks for utilities smart water may be seen as technologies and solutions that promote the implementation of the core tasks and improve management of water systems through knowledge from measurements, prognoses and planning

tools for instance by using data, online measurements and reporting as well as digital technologies. Contributing to meeting the global climate goals and the implementation of the UN sustainable Development Goals is also an objective for smart solutions.

Smart Water must focus on collecting data and taking better advan-

tage of the data we have. In addition, we must look into the broad area of activities that can be included and the many types of technologies such as remote sensing, online monitoring, artificial intelligence, robots and internet of things.

Together we should strive to be more innovative and creative. Then we can

find new solutions that we have not dreamed of before.

Digitalization typically involves collecting measurement data from a large number of measuring units (pumps, sensors, meters etc.) in the water infrastructure and ensuring that these data can be centralized, analysed, aggregated and utilized in



Thomas Breen,
Norsk Vann

"We are facing a challenging future, influenced by accelerating climate change, increased population in urban areas and aging water infrastructure. To meet this, the water sector will have to continuously focus on renewal of pipe systems and to seek innovative methods for monitoring and analysing water healthiness as well as methods for planning and implementation."



Osmo Seppälä,
FIWA

"Finding solutions for the challenges we are facing in the urban water sector demands that we work across sectors and cooperate more intensely with new partners. I am sure that using our knowledge, the data we have and will get, in smarter ways, will make us work more wisely together."

business intelligence tools. Therefore, the data quality is crucial in order to avoid digital mistakes.

The digital tools can be diverse and can include both business intelligence and monitoring tools as well as artificial intelligence that looks for patterns and deviations in relation to the normal situation.

It is important, when working with smart technologies, that the starting point is the individual utility's business needs, a focus on what the company wants to achieve and benefits that can be gained by implementing new smart projects.

We have seen that when private consulting companies, manufacturing companies and other stakeholders enter into close cooperation with water utilities, the parties will challenge and fertilize each other. Such cooperation will contribute to promoting technological development and green restructuring of the economy.

By learning from each other and collaborating across industries and technologies, we will be able to utilize each other's knowledge more effectively. This is not least

important in relation to the scope of the projects and to making the right decisions.

The above can be combined in a number of focus areas, where using data digitally will create effective solutions:

- Collection and utilization of relevant data from pumps, measuring wells, sensors, etc.
- Ensuring water quality when monitoring overflow
- Use of existing as well as new data for the planning and management of wiring
- Use of data in connection with the design of new wastewater solutions
- Notification in relation to cloudbursts and high tide
- Collection and coordination of inquiries from citizens

Use this Booklet to get inspired by the areas where smart solutions is used for the benefit of the environment and the citizens.

Our selection of Smart water solutions in the Nordics

The selected cases in this booklet aim to give you an insight into a number of technological possibilities within areas such as securing clean water, protection against overflow, collecting data and the use of the data.

The different cases should give inspiration to work on similar solutions or to take a step further in a continuous technological development that can be adapted to upcoming challenges that we as a society will face today and in the future.

The cases describe solutions that utilities can benefit from regardless their size. They demonstrate that when organisations are working together, challenges can be handled for the benefit of the citizens and the environment. The cases provide an insight into solutions that are based on new technology, the use of existing technology and the use of data collection from the infrastructure such as intelligent pumps, modern sensors, etc.

How can data be collected in a cloud-based technology, so that extracts subsequently can be used more intelligently in the management of the

infrastructure and enable an optimization of operating intervals, better energy use and reduction of overflow.

Another solution uses data collection to establish new processes with a focus on optimizing cleaning grades and utilizing organic material in connection with bioenergy.

We also present a solution to managing large amounts of stormwater, which is to collect rainwater in buffer tanks, including monitoring of precipitation volumes and focusing on predicting future precipitation by using radar technology.

Water utilities, municipalities and governments are working to secure clean water. It is important to protect the water resources and to monitor their state through direct measurements and continuous water samples - the focus here is on pH value, temperatures, chlorine and hardness. In this area, collecting data from different sensors and being able to utilize them effectively, especially when talking about very large amounts of data is of high importance. One of cases is an example of this.

CASE 1

BlueBox – Safer Water Distribution in Halden, Norway

Utilization of data to improve water quality

Achieving drinking water of high quality is intrinsically followed by a broad range of challenges, some related to social structures, to practical infrastructure and to tech-

nology readiness levels and adaptation. In Norway, managing open water sources takes place at state level, water intake and distribution is done by the waterworks, often at municipality level, and at the end of the chain, drinking water is individually

managed by the end users. Adding to that, the technology of online quality monitoring has not moved at the same pace as IT solutions, software fusion or artificial intelligence.

An added challenge to the project was the utilization of user data, blending system data across sectorial pillars of command - still targeting enhancement of both infrastructure data and user data. Keeping data integrity uncompromised even further adds complexity.

Overcoming the gap between available energy storage at the sensor site and the urge for more data as well as the transmittal of real time data added to the list of technical challenges in the project. Better and faster real time data provided to municipal service providers are key to achieving real time response to emergencies and tighter co-relations between stakeholders.

A solution based on improved monitoring and measuring

The system solution is divided into two zones:

Zone 1:

Advanced monitoring at reservoir/ water treatment facility (reservoir) with a water quality verification unit. These units are the initial quality data providers intended for reservoirs, water treatment facilities and main distribution lines, targeting real time water quality parameters and early warning of deviation from standards. Multiple means of communication and power supply options are available for the unit. With a solar power and battery-charging controller, a complete self-contained version is available.

Zone 2:

Smart fiscal flow units (in households) measuring water flow rate, temperature, absolute pressure, turbidity, return stop valve user/alarm based water stop and acoustic sensor for leakage positioning.

The total system setup provides a total overview for municipalities as well as personal data and control abilities to end users. The City of Halden has been involved in developing, testing and implementing the solution.



PHOTO HENRIK DISKERUD MEYER, HALDEN MUNICIPALITY

SmartCity Halden

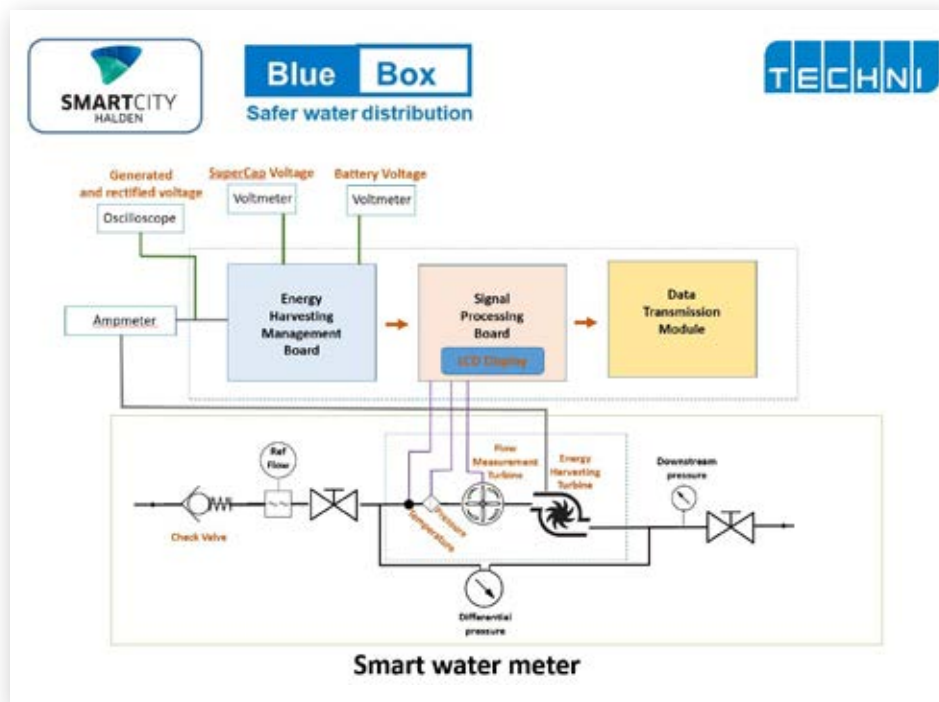
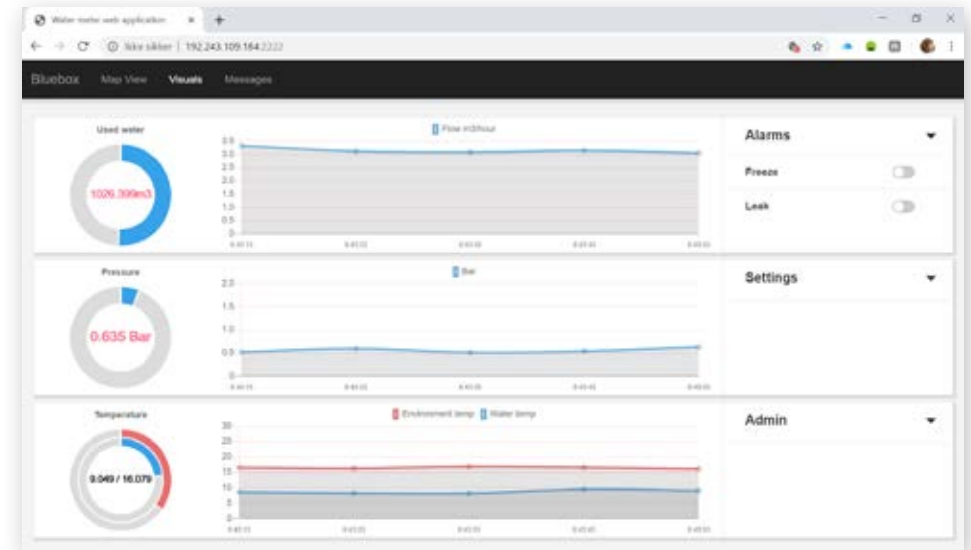

Illustration of the concept BlueBox, Techni.



The Water Meter web application, Techni

The BlueBox is a smart solution as it:

- Helps locate sabotage activity and increases system security
- Measures consumption, temperature, pressure changes, position of leakage
- Enables central or user control of flow and pressure locally or in large areas
- Is a self-charging system that provides uninterrupted online 2-way communication

- Integrates water quality monitoring in a system, central and user based control mechanism.

Smarter leakage detection and flow measuring is beneficial for utility and customers

In cooperation with the companies Techni, Smartlab, Telenor and Microsoft, the municipality is in the process of developing a new forward-looking smart water meter.

The meter have a dynamo that will generate power and the water meter is connected to the internet via the new Narrowband - Internet of Things (Nb-IoT) network. This means that residents can read their own water consumption and possibly close the water regardless of where they are.

The municipality will also place smart water meters around the main water pipes so that it becomes easier to find out where there are small leak-

ages in the water pipes, which gives significant loss of water in the distribution systems. They also plan to put a small sensor in the meter that can monitor the water quality.

BlueBox - the water meter of the future.
Halden, Norway

CASE 2

Smart urban water systems using real-time management in Tampere, Finland

Development of an application for publishing real time water quality data in internet.

According to surveys targeted at customers, more information on drinking water quality is requested. In addition, sufficient distribution of water quality information is also notified as a demand in Finnish Act on Water Services.

The build-up of a real-time management system for water quality information was started by developing an accurate on-line model for the water distribution network. The on-line model enables further distribution modelling of several water quality parameters. On-line measurements, e.g., of temperature, pH and chlorine residual are also utilized. The real-time management system checks the information from the SCADA system once in an hour and simulates the water quality parameters in 10,000 counting stations providing average quality values in chosen specific water distribution areas.

Sharing water quality information with the customers

Vellamo is a Tampere Water service that shows the quality of the drinking water in the Tampere water supply network based on up-to-date observations and over 10,000 counting stations and geographic information.

Through Vellamo, Tampere Water offers open data material presented in a searchable format. Water consumers can search the service for values describing current water quality in specific area as well as browse prior information. Tampere Water offers a web interface to water consumers and an open interface to software developers with access to some of the data generated by the online model.

At present, these four factors are shown: pH, temperature, chlorine and hardness.

Tampere is the third largest city in Finland and the largest inland centre in the Nordic countries. Tam-

pere water supply system covers a network of approximately 780 km. The quality of the water entering the water supply plants and water intakes and, from there, the distribution network is monitored by conducting analyses in laboratories

and using the automatic indicators installed in the plants. Samples are also regularly taken from numerous points along the different parts of the water supply system (such as some day-care centres).

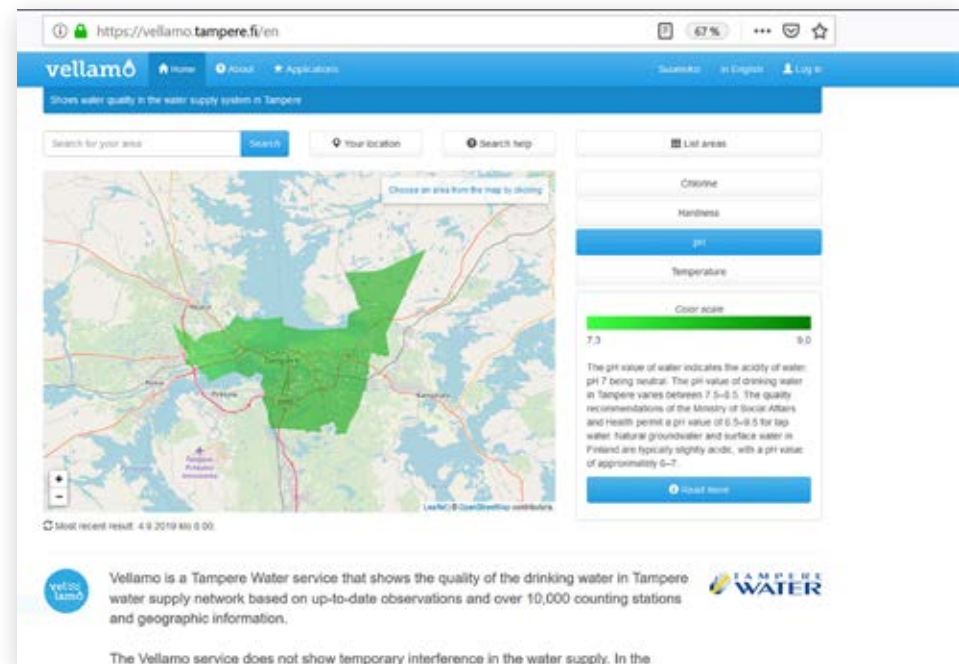

Vellamo front page. Water consumers can search the service for values describing current water quality in a chosen area.

The Decree of the Ministry of Social Affairs and Health Relating to the Quality of and Monitoring of Water Intended for Human Consumption sets the quality requirements and recommendations. In addition, the City of Tampere Environmental Health monitors water quality based on samples collected from different points in the water supply system.

Up-to-date information provided for customers and utility

The presented information comprises computational values generated using a water supply system model, based on measured observations in the actual system and water production plants. The computational results are updated every hour, so the values show an up-to-date situation in the different areas of the water supply system.

The system distributes actual, measured water quality data in the water supply network practically on-line. The water quality data measured only in certain points of the water supply network are spread to cover the whole water supply network. The system can act as a platform for future development with addition of new water parameter analyses or measurements.



The water supply system in the city of Tampere covers a network of approximately 780 km. New underwater mains pictured waiting for submersion.

Satisfied customers through improved information

The system increases knowledge about water quality in different parts of the network and thus improves customer satisfaction. Customers gain access to up-to-date water quality data in an understandable form. The data are easily accessible by mobile connections 24 hours in a day. The data are presented on a map that can be conveniently zoomed enabling both overall view of the total water supply network area and a more detailed view of a partial area.

The system improves interaction between the customers and the utility. It also increases information dissemination on water quality notified in the Water Act on Water Services and helps the utility to maintain its good public image.

The utility can use the system for further development, e.g. by the addition of different on-line water quality measurements. The system also gives the utility possibilities to develop new services for customers, both commercial and free-of-charge.

Vellamo - Shows water quality in the water supply network in Tampere; pH, temperature, chlorine, hardness. The computational results are updated every hour. Web interface to water consumers, open interface to software developers. <https://vellamo.tampere.fi/en>

CASE 3

An efficient water utility using digital wastewater developed in Provas Network, Haderslev, Denmark

Accumulating real time data from the sewerage system

In May 2017, a collaboration between Provas (The Utility of Haderslev, Denmark) and the pump manufacturer Grundfos started. The purpose is to handle challenges related to infiltration water, overflows, need for smarter alarms, and asset management and energy consumption in the wastewater system.

"If we are to serve our customers as well as we do now, in the future, then we must work more efficiently. We have many data, but we have not had it analysed properly. The Grundfos system will do this for us via automated processes," says Casper Koch Nordow, Operations Manager at Provas.

The new system generates an up to date job list daily for a water utility operational manager in wastewater, turning service from a reactive approach to proactive service

strategy. The system will analyse the data to indicate what the technical problems are - for instance, if power consumption and pressure increase at the same time, it could mean constipation within the system and a risk of overflow.

Improve utility management

Grundfos iSolutions Cloud for Wastewater Networks (GiCWWN) turns sewer network data into actionable information for network operators, providing real time visibility of hydraulic and mechanical conditions. At its foundation is an algorithmic flow estimation. The system can estimate flow without relying on flow meters.

This solution has five modules: Actual Flow, Infiltration Flow, Capacity Utilization, Overflow Warning and Predictive Maintenance. Actual flow gives insight into the actual flow in sewer pipes to calibrate hydraulic models, simulate how additional flow



Operations manager Casper Nordow Koch, Provas, is excited about the prospect of transforming real time sewer network data into actionable information and ultimately optimize the efficiency the sewerage system.

will affect the system and determine which sewer lines to rehabilitate.

Infiltration Flow determines how sewer flow is linked to rain or ground water infiltration. It categorizes flow per catchment area and accumulated flow into fast or slow infiltration. This supports sewer refurbishment (rain flow is typically linked to

pumping station lids and pipe misconnections).

Capacity Utilization is used to visualize utilization of pumps and pumping stations over time in relation to flow and energy consumption. It functions like an audit of the pumping station and pump function, showing the amount of water moved compared

to the full capacity of the pumping stations. High utilization could possibly mean that pumps could be too small and operating on the right side of the efficiency curve. In which case, money can be saved by investing in larger pumps (vice versa with low utilization). Additionally, low utilization increases retention time with higher risk of H2S generation.

Overflow Warning offers proactive overflow warnings when the water level increases due to the pumps not performing at full capacity. The system helps pick out important events from the constant background of unimportant SCADA alerts and it warns of potential problems in advance of conventional monitoring systems.

Predictive Maintenance is an asset management system, used to prolong the life of equipment and prevent unexpected breakdowns. This module transforms data into actionable insights, optimizing operations or preventing breakdowns. It compares a running average with data from the previous 30 days to detect changes in network behaviour.

Smart information and instant action

GiCWWN data in a sewage network is translated into actionable insight

for planners or operational managers to use as working instructions to save time in troubleshooting, in doing their own analysis or reducing the hours of alarms. The translation is done by algorithms based on Grundfos knowledge of hydraulic, pump and applications, which are the core of the system. Currently water utilities pay consulting/ service companies a lot of money for audits to calculate infiltration, actual flow in pumping stations. GiCWWN provides this information on a continuous, real time basis at lower costs.

Access to real time utilization data based on pumping station capacity enables energy optimization. Accurate, proactive overflow alarms help reduce the number of site visits to check alarms and reduce the number of overflow events. Experience shows that predictive maintenance reduces the number of alarm visits by eight a year/pumping stations (both in and out of working hours).

Utilities can benefit from better use of data

The combined work between Provas and Grundfos resulted in a tool, which fits to help solving the daily challenges in a water utility. The aim of the collaboration between Provas and Grundfos was to solve the most cumbersome issues through a com-

bined value-added process, where employees from both organizations brainstormed, listened, discussed and specified potential solutions.

The benefit for other utilities is a solution, which solves some of the practical issues in water utilities based on a data driven approach: Data is analysed and translated so that a water utility technician can easily take action, to solve a problem.

"I am very proud that the know-how of the employees in Provas has contributed to the development of

Provas and Grundfos co-created a solution to solve daily wastewater challenges

a customized digital solution that meets the specific needs of the industry: it optimizes our workflows substantially and thus supports our efforts to run operations with greater cost-efficiency. The industry needs more tools like that in order to keep down tariffs and maintaining a high level of customer value," says CEO Esge Homilius from Provas.

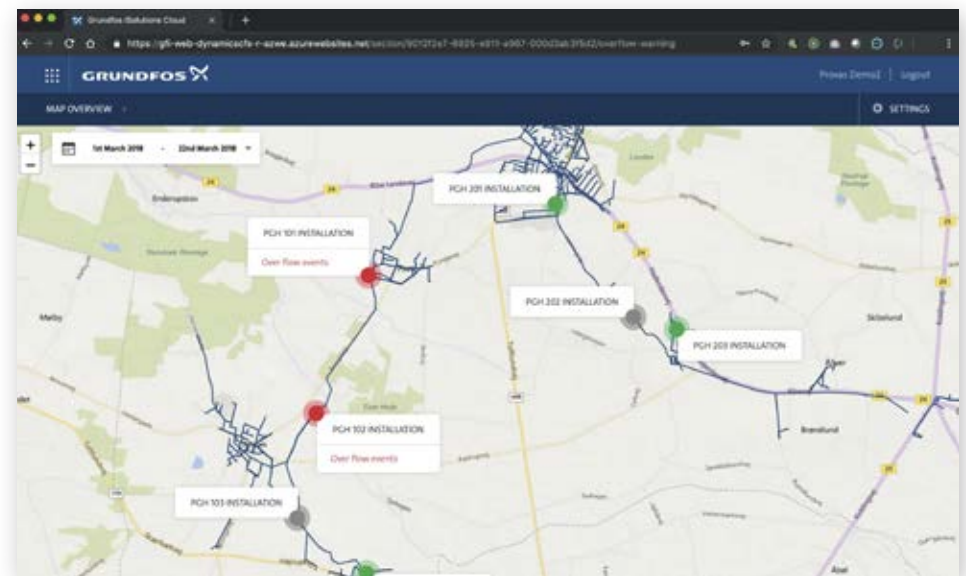

The co-creation process resulted in Grundfos iSOLUTIONS CLOUD for Wastewater Networks, the first commercial offerings to detect infiltration, where flow in the network is broken down into fast versus slow infiltration, a module to enable a predictive maintenance strategy, a proactive overflow warning and finally a module showing capacity utilization of network assets.

CASE 4

Lungegaarden Data Lake in Bergen, Norway

Need for smarter data use to secure water quality in Norwegian fjords

Bergen municipality has huge amounts of data stored in different IT-systems. The original data systems are normally isolated, and exchange and use of data between the different systems and sectors are very limited. For example from the water field alone, more than 13,000 monitoring points are recording real time data every minute.

There is a need for storing this high-resolution real time data from the SCADA system and making these data available for both internal and even external use in some cases.

The question for Bergen is how to share and utilize these data in a smart and secure way in order to provide good services to the customers and to safeguard a good water quality in the fjord. The real-time

data should be easily available for the operators in the field on their preferred IT-platform (Gemini Portal) and the historical data serves a valuable data source for further advanced analytics such as artificial intelligence (AI) and machine learning (ML) etc.

A system to store real-time data

Bergen municipality has established a data lake for storing real-time data for different municipal sectors included the water sector. The data lake is named Lungegaarden, after the small local lake in the city centre of Bergen.

Every minute data from 13,000 measuring points from the water and wastewater system in Bergen are collected and stored in the data lake. Each of the sensors or monitoring points contributes with more than 500,000 data values each year.

Over time and with many sensors this leads towards huge amounts of data and the need for some type of big-data analysis. Within the framework of the data lake, the municipality develops their own apps and tools for visualizing and analysing

the data, but also external software companies are building their own cloud-based solutions on top of the data lake Lungegaarden.

One of the first solutions developed is about making data from the SCADA system available for the water and wastewater operators in the field. The operators for the wastewater systems are using tablets with Network Information Systems (NIS) and visualizing the relevant real-time data for each wastewater object is useful in their daily work.

The solution is developed in close cooperation with different municipal departments (IT, Water & Wastewater) and external consultants and software companies as a cloud based solution.

Smart data storage provides new opportunities for their utilization

The innovative part of the solution is the storing of the data in a cloud based data lake, which opens up a window of opportunities for utilizing the data, e.g. related to identifying water leakages or early detection of

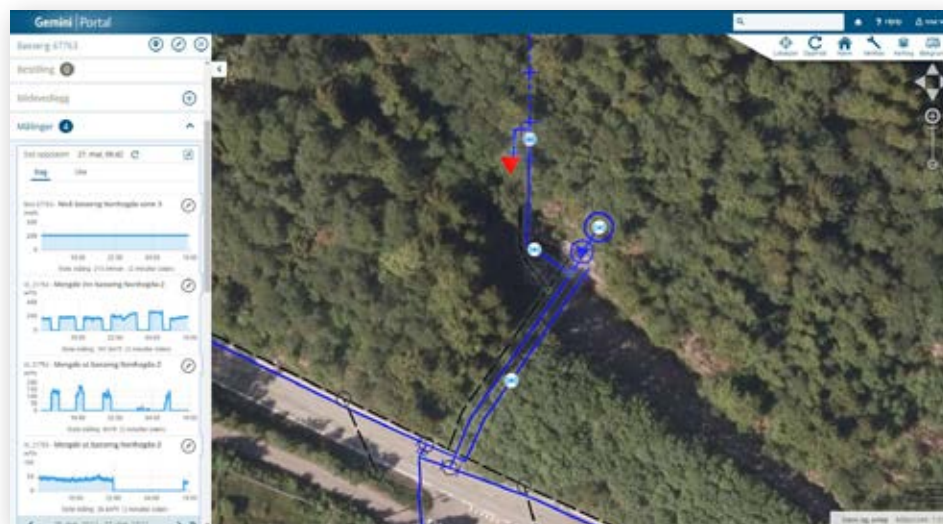

Real-time data made available in the network information system (NIS) of Bergen by utilizing data from the data lake Lungegaarden, Bergen Municipality



PHOTO: BERGEN MUNICIPALITY

Every minute data from 13,000 sensors are stored in a data lake in Bergen, Norway

The city of Bergen where lake Lungegaarden has been replaced by a digital data lake.

pump failures. When storing, sharing and utilizing real time data from critical infrastructure like the wastewater systems, cybersecurity issues are a major concern.

Bergen municipality is already a partner of the ongoing EU project STOP-IT and has a strong focus and awareness on cybersecurity issues. Cyber security issues are relevant for the data-lake for different aspects.

Examples of issues, which have been considered are communication and receiving data from the SCADA systems (e.g. "push not pull data"), sharing of data and personal data issues (General Data Protection Regulation - GDPR), identification of information-values and communication and with external cloud-based solutions.

Linking real-time data from SCADA to water infrastructure assets and

making the data available for the operators in the field will lead to better decisions and improved communications between operators and planners.

Implementing the SDG's in a smart city

Bergen is a first mover in Norway for collecting "all" real-time in a municipality in a central data-lake making the data available for visualization,

sharing data and more advanced analytics. This is a part of a "digital first-strategy" and in line with Water Europe's vision on Digital Water.

The overall benefit from the project is to contribute to solve some of the UN's Sustainability Development Goals (SDG's) within a smart city context. Water and wastewater services are important elements in this.

The overall objective is as always to continue to provide good services to the citizens and maintain good water quality in the receiving waterbody, the local fjord Byfjorden.

The data-lake is also compliance with a more open data policy to the society and citizens might even in the future build their own apps based on relevant open data from the data-lake.

CASE 5

Smart Cities - Greenergy in Fredrikstad, Norway

Innovative solutions for water, sanitation, stormwater and energy

Modern cities must optimize well-being and that includes minimizing environmental impact. This case demonstrates that when engineering comes closer to the users the awareness and wellbeing will increase. The concept described below is GREENENERGY and it includes innovative solutions for water, sanitation, stormwater and energy.

GREENENERGY will reduce water consumption, by using water saving fixtures as vacuum toilets, facilitate recycling of nutrients to urban and peri-urban agriculture and thus, almost eliminate pollution of surface water.

Biogas production from toilet waste (blackwater) and organic household waste (OHW) is a key treatment technology. CO₂, heat and power from biogas combustion is utilized together with the nutrient rich retentive in a super-insulated greenhouse for local resource reuse and year around plant production.

Advanced wastewater management in Norway and China

The advanced system is being showcased in the Norwegian city Fredrikstad and the Chinese city Changsha. In the Showcase Fredrikstad, the wastewater is separated into two fractions - toilet waste (blackwater) and greywater.

A vacuum system is used for collection of blackwater and grinded organic household waste, followed by a biogas reactor (heat from the reactor will be used for heating a greenhouse during the winter season and effluent from the reactor will be converted to solid and liquid fertilizer). The greywater will be treated locally to good bathing water quality when it comes to indicator organisms.

A communications platform to facilitate advanced treatment

Scanwater has started working on developing the concept GREENENERGY, that will include all technologies described above. We are designing the communication platform with input and outcome as illustrated



Showcase illustration in Fredrikstad, totally 1000 apartments, NielsTorp+ Architects

in the picture below (here with the example where communication done through WeChat for the citizens).

Greenergy, demonstrated at Cicignon in Fredrikstad, will lead to a significantly lower discharge regarding both volume and pollutant load than traditional plumbing fixtures. Water consumption can also be expected to be 20-30 % lower than today experiences.

This opens new possibilities for future development of municipal sewer handling. If new development does not increase the burden on the existing systems, the existing col-

lecting sewers and corresponding treatment systems may operate longer without new investments and upgrading.

In Fredrikstad today, there are plans for upgrading of the sewer networks and treatment systems that will be both very costly and may require increased pumping and consequently energy use.

Better service - and more climate friendly

The combined work between Scanwater, Roediger (vacuum sewer supplier) and the University NMBU will give basis for the platform Greenergy.

Modern Cities must adapt systems for saving and reusing water. This will create better understanding among the citizens ("engineering" will be closer to the users) and create new opportunity for business cases (for example Urban Agriculture/food production using resources from water and waste produced in the city itself).

We will demonstrate that Greenergy will create an energy surplus of 175 kWh/person per year. Totally, we expect to be able to reduce the climate footprint from the traditional water and sewerage sector with at least 50 % compared with today's system.

- Greenergy will:**
- Reduce the water footprint up to 90 %
 - Safe recycling of Nutrients for Urban food production
 - User friendly Control and Communication Platform

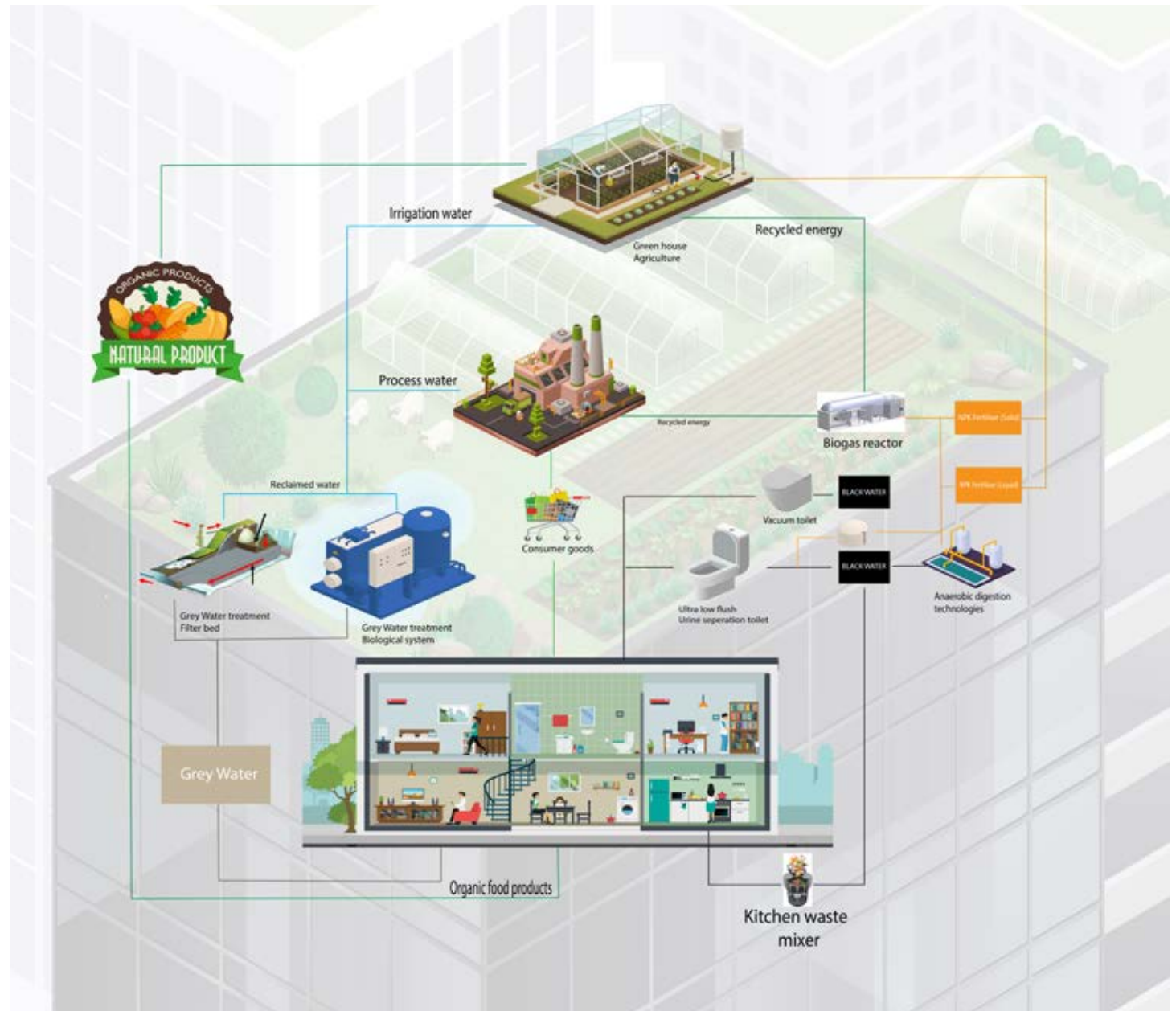

Illustration of the concept GREENERGY, Scanwater

CASE 6

Stationary Overflow Monitoring System (SOMS) saves operation and ensures the water environment in Skanderborg, Denmark

Smarter ways to control overflows

Untreated wastewater discharged to recipients is likely to cause an imbalance in the ecosystem. This happens when the system overflows due to bursts or blockages, plant spills, storm water overflow or the like. Especially with the increase in extreme rain, overflows are expected to become a recurring event, which is why there is a critical need for smart solutions for utilities.

As municipalities have set up environmental requirements where overflow measurements can help utilities with compliance, and manual monitoring of overflows has disproven itself as being a cost effective method, SOMS has shown to be an important tool.

By increasing the effort to reduce wastewater overflow, the volume of untreated wastewater discharged to

receiving waters, can be reduced. In turn, this leads to an improved environment, including a healthier bacterial balance and a better quality of public recreational water.

The Stationary Overflow Monitoring System will provide data to support decision making focused on conducting a prioritized effort to reduce overflow, and can furthermore assist in determining the precise effect of the reduced environmental impact.

From a financial perspective, the solution facilitates more efficient and cost effective asset management as well as enabling value added investments. In terms of maintenance operations, it allows for the utility company to move from scheduled maintenance to predictive and preventative maintenance.

Using advanced monitoring tools

SOMS is a combination of Danova's data logger D Log, the overflow camera D Eye and a level meter - in this case a radar.

D Eye, an add-on to D Log, is an online battery-powered camera. It is primarily developed for photo documentation, in harsh environments without light and with high concentrations of moisture, gases and the like, such as Combined Sewer Overflows. With key features such as water-resistant design, humidity monitoring off the cameras environment, and uniquely heated glass, for moisture/dew-free lens and flash. The cameras intended use is for documentation of the overflows function and structure, exclusion of fault sources such as rebound, defective/slammed grates, sea flaps etc.

Amongst other SOMS can help solve the following challenges:

- Information about discharges to recipient
- Clarification of the function of the overflow structure
- Measurement and calculation of discharged flow and time
- Number of conditional/unconditional overflows
- Prepared for connection of local rainfall meter



PHOTO: BRIAN RASMUSEN/FOTOGRAHUSET

Danova D-Eye, is not just a camera – it's a technical "masterpiece". Build in functions such as humidity surveillance, temperature measurement, unique transparent heated glass, automatic camera light selection with both LED and Infrared is just some of the features. Specifically designed for the use in sewers, with limited or no light, and often very humid environment.



As sewer overflows are often very remote, and rarely established with a main power source – the complete system is battery powered, with the possibility of direct connection to a small solar panel, for permanent operation.

- SOMS is prepared for connection of local rainfall meter

Smart data logging improves monitoring and reporting of data

The newly launched data logger D Log has built-in algorithms, which by a simple contactless level measurement on the grid, can calculate flow quantity, time recording, separation of conditional/unconditional overflows, number of overflows etc. All together and calculated in the same report.

The large resources that Skanderborg Utility uses on manual inspection and flushing of grids after rain events are minimised, whereby the payback time is very short. This solution costs about a fourth of traditional flow measurement methods.

Typical locations for overflow structures are very remote and rarely established with fixed current. Therefore, this solution is battery powered - in this case supplemented with

solar cells - and therefore requires no other installation, or prior preparation. Thus, the solution can easily be moved to another location as needed, or it can be used as a permanent measurement.

Data from the measurement points is delivered via data network to Danova data server, and from here, it is integrated into the existing SCADA system according to the highest safety standards.

To illustrate the endless possibilities with D Log, in addition to the above, one has chosen to connect a rain meter, as well as a water level meter in nearby groundwater drilling. Everything for one and the same data logger on battery operation.

Solutions developed in local partnerships contributes to meet global goals

With the partnership, AquaGlobe Skanderborg Utility has developed a concept for Test & Prototyping, Demonstration sites and Water Visits.

The collaboration between Danova and Skanderborg Utility in AquaGlobe has opened the possibility to display Danova's innovative overflow registration and documentation system SOMS (Stationary Overflow

Monitoring System) - with AquaGlobe as the frontrunner.

SOMS contributes to the UN's Sustainable Development Goals through strengthened partnerships that promote water efficiency and wastewater treatment technologies, as well as effective planning and management related to climate change and the protection of vulnerable recipients. Through AquaGlobe we ensure better access to technology and knowledge, and strengthen the opportunity to share ideas and promote innovation.

AquaGlobe's concepts for collaboration make it easy to start a process where interested people can test and prototype their products, demonstrate them to their customers and explain how their product contributes to an efficient utility that is sustainable and environmentally friendly while providing for their consumers in a cost effective way.

"Overflow with risk for direct environmental pollution is a growing problem - We use the technology to stay ahead"
Trine Balskilde Stoltenborg,
Skanderborg Forsyning

CASE 7

Use of X-band weather radar data against urban flooding in Southern Sweden

Controlling increased urban flooding

The purpose of this project is to benefit from the two X-band weather radar facilities in Western Scania, Sweden that provide high-resolution precipitation data with a 50 km coverage radius from the cities of Lund and Helsingborg (Sweden). The project is a joint collaboration work between Lund University, Nordvästra Skånes Vatten och Avlopp (NSVA), Swedish Meteorological and Hydrological Institute (SMHI), Sweden Water Research and VA SYD.

The Öresund network of X-band radars, two in western Scania and one in Copenhagen, creates a unique research environment where the radars can support each other when there is a cloudburst. With only one X-band facility, the signal can be blocked by cloudbursts. This weakness will be removed with the other two radars. The resolution with X-band radars is approximately 100 x 100 m compared to 500 x 500 m (Dansk Meteorologisk Institut - DMI) and 2 km x 2 km (SMHI) with conventional C-band radars. The high-reso-

lution precipitation data is essential as input data to urban flooding analysis and for hind cast analysis.

Two key challenges for the technique:

- Calibration of the weather radar
 - without this the radar data will make an inaccurate estimation of the rain intensity and accumulated rain during a rain event.
- Development of methods for improved forecasting capability.

Advanced use of radar to monitor rain events

After a successful test period during the summer of 2018, a permanent X-band weather radar facility was installed in April 2019 in Lund. The radar offers services in Scania via an open webpage platform (<http://vasyd.informetics.se>) to monitor rain events with an updated radar image every minute.

After a complete calibration of the radar, the precipitation data can be implemented in numerous ways such as:

- Input data for real-time control flow models (e.g. the Future City Flow project) and neural networks/machine learning applications e.g. to predict flows to Wastewater Treatment Plant (WWTP).
- Combined C-band (conventional weather radar) and X-band weather facility offers improved rain prognosis-based automatic control at pumping stations and wastewater treatment plants.
- Combined with rainfall monitoring based on microwave links from cellular telecommunication networks further to improve the precipitation description.

Suggested project ideas for 2019/2020 where the radar data will be applied:

- Weather based control of pumping stations
- Input data for the Future City Flow project where a real-time control model can predict future incoming flow to wastewater treatment and optimize the control of the system as a whole. The radar data

improved the input of the model and in that way, also the quality of the prognosis tool from the Future City Flow project.

In the late autumn of 2019, the radar in Lund will be complemented with second radar that is being installed in the city of Helsingborg. In both radar sites distrometers that for example measures raindrop-size will also be installed to get an even better calibration.

Development of smarter warning systems based on radar data

The X-band radar will be integrated with other methods of precipita-

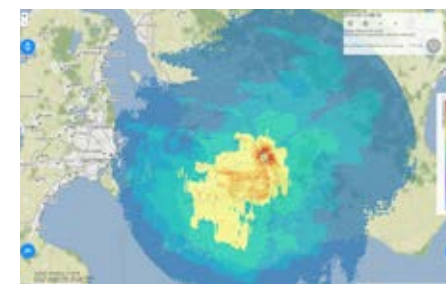

Image from radarwebsite with local, high-resolution accumulated values during a rain event over the Scania region



The X-band radar facility on top Dalby water tower in Lund municipality

The weather radar project is a broad collaboration project initiated in 2018 where public water utilities and municipalities in Scania, Sweden, together with Lund University and SMHI as key partners evaluates the X-band radar technology and its potential applications in the sewage treatment industry.



Malmö Centralstation

tion measurements and used as and measurement and prognosis tools, which can be applied for water services and hydrological purposes.

Svenskt Vatten funded a pilot study in 2018 that indicated that the Lund radar could be used to device a warn- ing system in the future with a mar-

gin as a best case from 0.5-1 hour. A collaboration with the corresponding radar facility in Copenhagen could extend the observational range of the radar further based on the condi- tion that the rain fronts come from the west.

Combined with conventional C-band radar, the X-band radar can con- firm the magnitude of incoming rain fronts and indicate if there is a risk of cloudburst events in Scania. With this project, the first Swedish research weather radar was installed and it will contribute to the whole industry with the latest conclusions within radar technology applied in the water- and wastewater sector.

Improved information and control of extreme events

The radar facility in Dalby offers:

- A way to monitor rain events and potential cloudbursts
- Improved control of the wastewater system using real-time control flow models and machine learning. This can potentially reduce energy cost and excess overflow of wastewater to local recipients. Optimizing the system as a whole can also increase the performance of wastewater treatment plants.

- Improved high-resolution input data to urban sewage flow models which increases the quality of the results. Based on the flow model, the results highlights weak sections in the sewage, which could cause urban flooding. Thus, effort can be made to prevent hazardous situations for the water utility costumers (urban flooding) and to reduce financial cost for the water utility e.g. lawsuits.

In addition, the radar facility could provide, as a best case, a one-hour time margin in the future, which offers emergency services and sew- age facilities an opportunity to prepare and alert their personal of a potential cloudburst event. For example in the wastewater sector this margin can be used for empty- ing underground storage basins and rinse the lattices at wastewater treatment plants. The same principle can potentially also be developed to alert the public prior to severe rain events and thereby possibly reduce or prevent the effects of flooding during future rain events in Scania.

CASE 8

Future City Flow (FCF), Sweden

Need to upgrade wastewater systems to improve the environment

Aging water infrastructure, climate change with larger volumes and more intense rainfall and urbanization leads to increased stress on our wastewater systems. This leads to increased amounts of water in the sewer network causing combined sewer overflows (CSO's), flooding and increasing overflows of untreated wastewater to the environment.

Considering wastewater management - Inflow and infiltration (I&I) in wastewater systems have been a cause of rising concern for many years. The effects that urban water has on receiving waters and their long-term biological and chemical status has presented wastewater utilities with the need to make significant investments to mitigate these problems. Storm water from areas with combined sewers, faulty connections or leaks in duplicate systems as well

as groundwater intrusion and rainfall-induced infiltration can cause flooding of basements or discharge of sewage via overflows to receiving waters.

Use of gaming to improve storm water management

Future City Flow is a web based decision support system that combines hydrodynamic simulations, key performance indicators (KPI's), and cost benefit analysis for strategic long term planning.

The aim being, to reduce stormwater-inflow and infiltration entering sewer systems. Future City Flow is an educational and effective tool that uses serious gaming to help the users find the most cost effective solutions for their city and their unique system, small or large.

It has a simple and pedagogic way of presenting information, with a high focus on the user experience, including wizards and online help. Cost

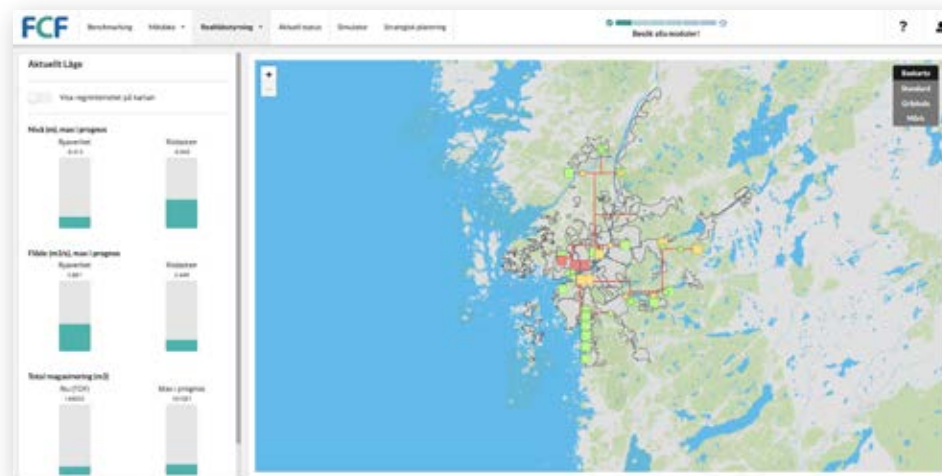

Example from the Future City Flow platform



Example from the Future City Flow platform

efficient investment alternatives are shown in an easy understandable and attractive way for decision makers and stakeholders.

Cloud based application for economic planning and management

Future City Flow is a cloud Azure based application with modules for benchmarking - evaluation of historical trends and actual state, automatic real time monitoring data analyses with KPIs for trend analyses and follow up. A real time control module using model predicted control operation, strategic action planning with yearly budgeting against alternative goals, as well as step-by-step guidelines with best practices for inflow/infiltration management.

The built-in simulation capabilities within FCF allow continuous long-term simulations covering years within minutes, thanks to a new surrogate modelling methodology developed. This is the backbone of the serious gaming environment that opens a new world for non-expert modellers. The real time control solution uses rainfall forecasting combined with a model-based approach to predict the nearby future rain, and using model-predicted controls, select and implement the most optimized operation at each time.



Control panel at Rya wastewater treatment plant in Göteborg, Sweden

Improving decision making and prioritization among different options

Future City Flow provides the utility with a model based driven application that optimizes the operation of the wastewater system in real time as well as supports identifying the most cost efficient priorities of long-term investments to reduce the negative effects of infiltration inflow. We want to ensure that all urban water is handled sustainably by utilizing green infrastructure, optimizing use of our existing infrastructure instead of creating floods or discharge of untreated wastewater.

- Reduced discharge of untreated wastewater: Increased water quality in our waters, in which people can enjoy a swim and our natural habitat will thrive.
- Reduced flooding: People do not need to worry when rain is expected, and insurance companies are reducing their reimbursements.
- Reduced wastewater treatment costs: Reduced use of chemicals and lower operating costs.
- Cost efficient long term planning of I&I management, reduces the investments and makes more efficient use of existing infrastructure.

Future City Flow (FCF) started as an innovation project partly financed by the Swedish Innovation Agency, Vinnova during 2016.

The idea is to create a digital decision support system that can be used for both long term planning of the sewer network for city planner and for short time optimization and real time operation of the wastewater network.

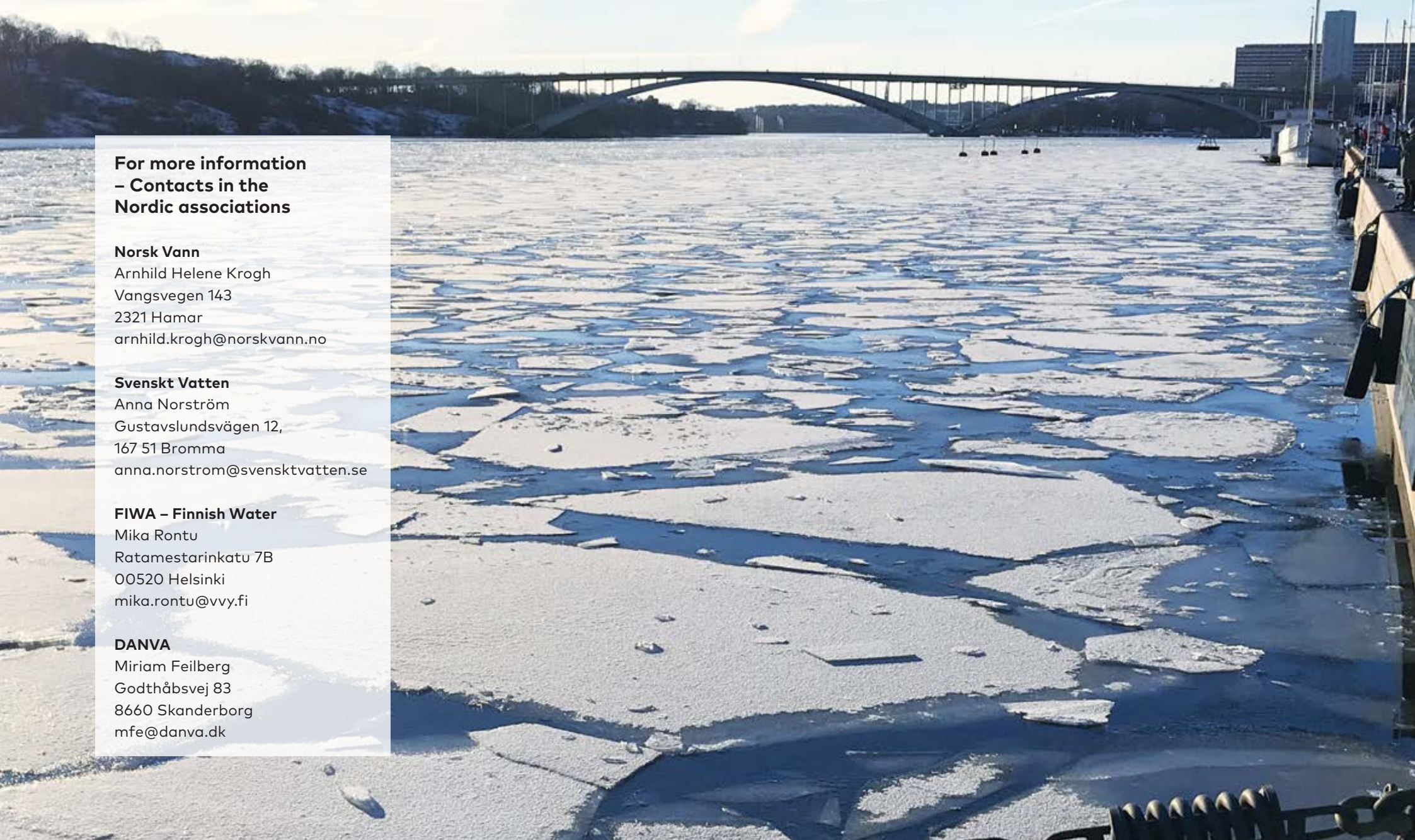

**For more information
– Contacts in the
Nordic associations**

Norsk Vann

Arnhild Helene Krogh
Vangsvegen 143
2321 Hamar
arnhild.krogh@norskvann.no

Svenskt Vatten

Anna Norström
Gustavslundsvägen 12,
167 51 Bromma
anna.norstrom@svensktvatten.se

FIWA – Finnish Water

Mika Rontu
Ratamestarinkatu 7B
00520 Helsinki
mika.rontu@vvy.fi

DANVA

Miriam Feilberg
Godthåbsvej 83
8660 Skanderborg
mfe@danva.dk